









R-Go Flex Read

RGODOFRTR

English manual	p.2	
Deutsche Anleitung	p.5	
Manuel en français	p.8	
Nederlandse handleiding	p.11	
Polski podręcznik	p.14	
Manual en español	p.17	
Manual em português	p.20	
Manuale italiano	p.23	
Svensk manual	p.26	

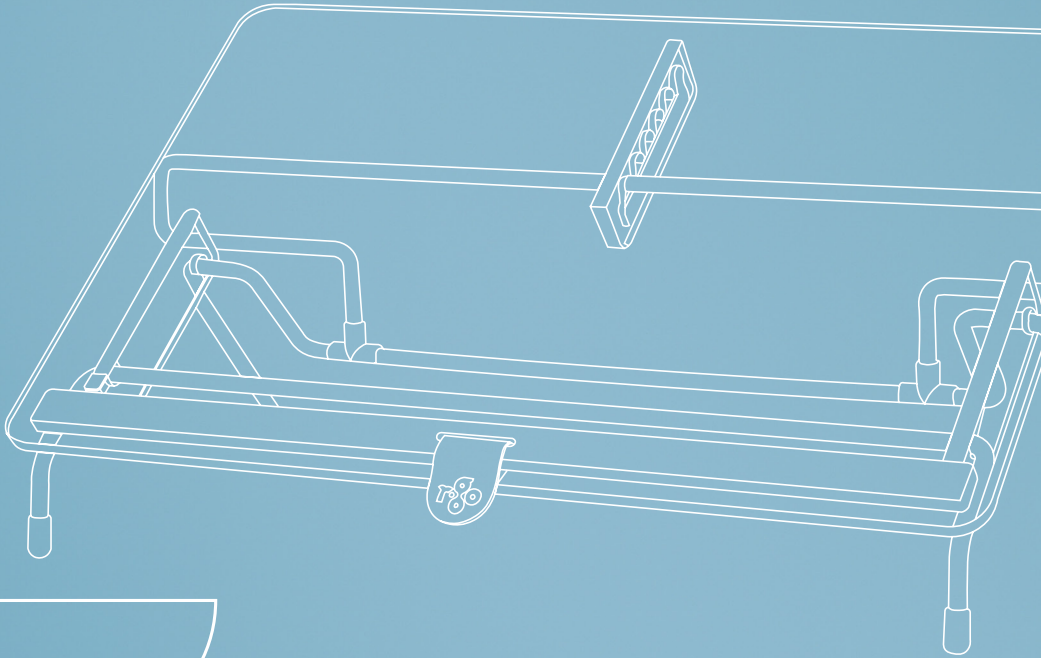

ergonomic document holder

R-Go Flex Read

Setup

Step A

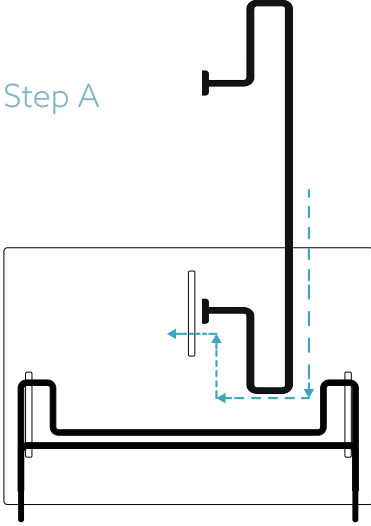

Step B

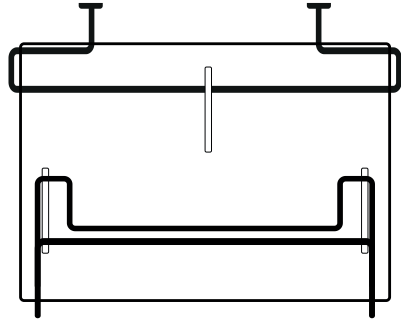

Step C

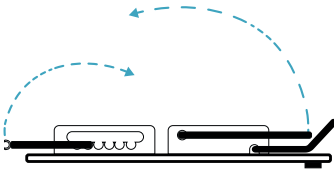

Step D

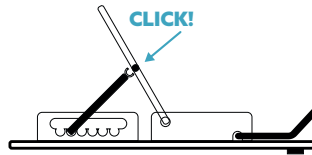

Step E

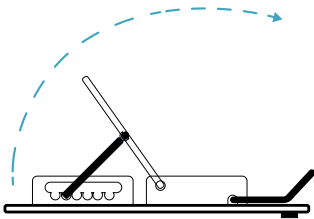

Step F

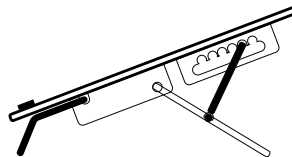

Final product

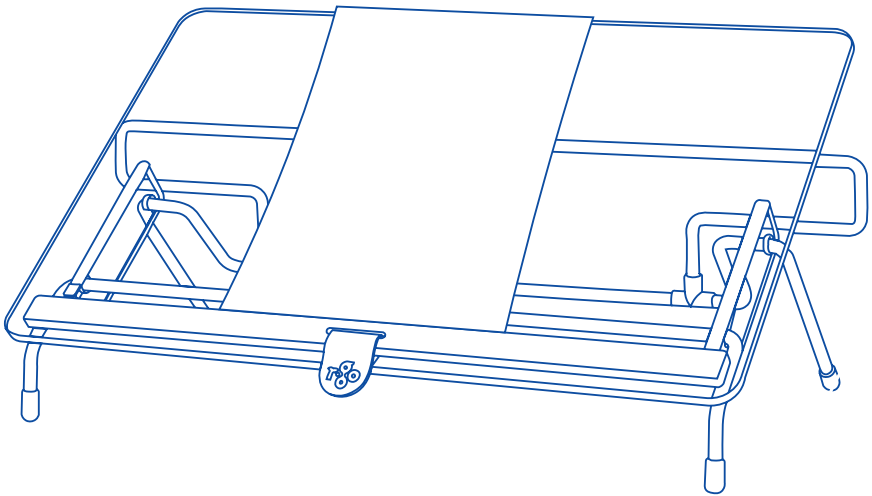

For more information
about this product,
scan the QR code!
https://r-go.tools/flexread_web_en

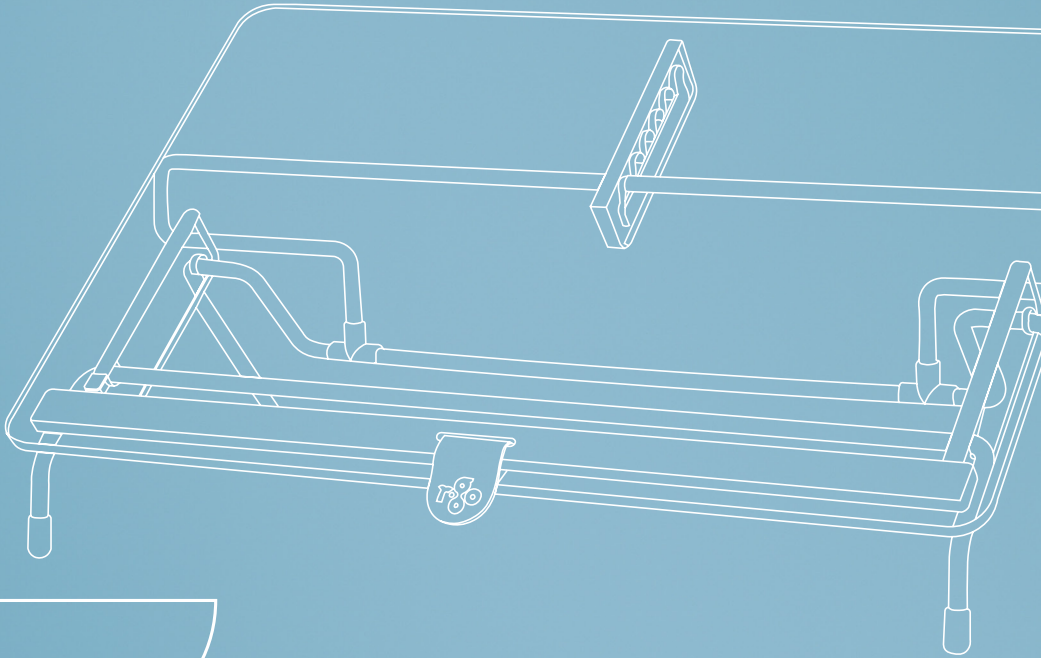

Ergonomischer Dokumenten- halter

R-Go Flex Read

Einrichtung

Schritt A

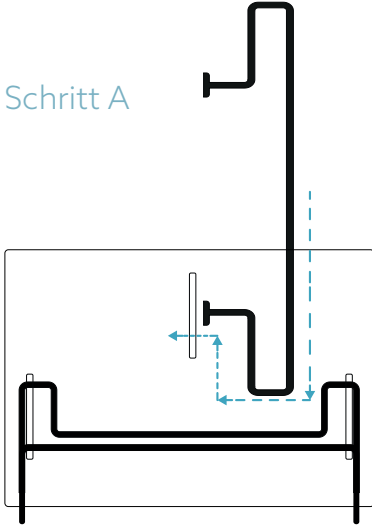

Schritt B

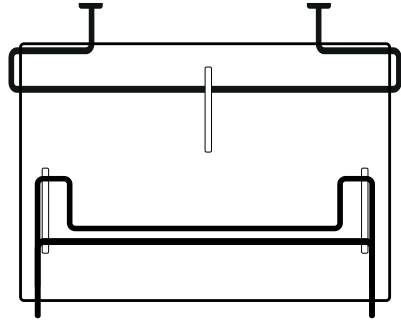

Schritt C

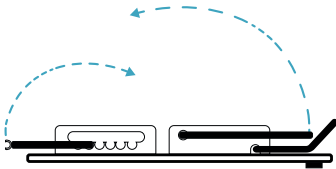

Schritt D

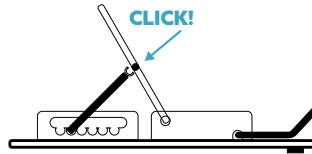

Schritt E

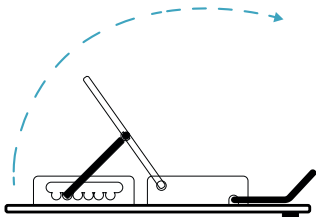

Schritt F

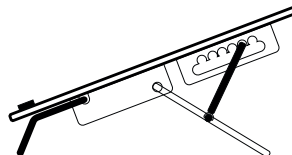

Das endgültige Produkt

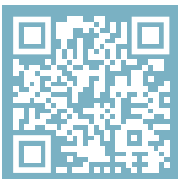
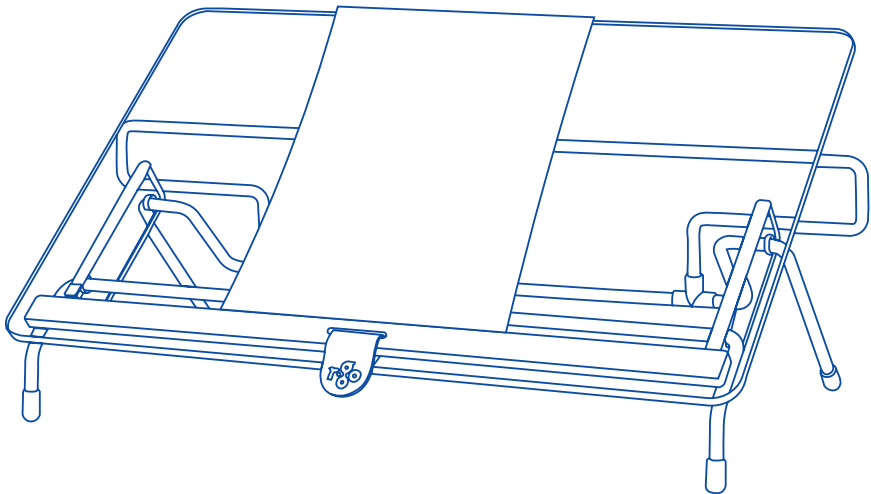

Für weitere Informationen
über dieses Produkt,
scannen Sie den QR-Code!
https://r-go.tools/flexread_web_de

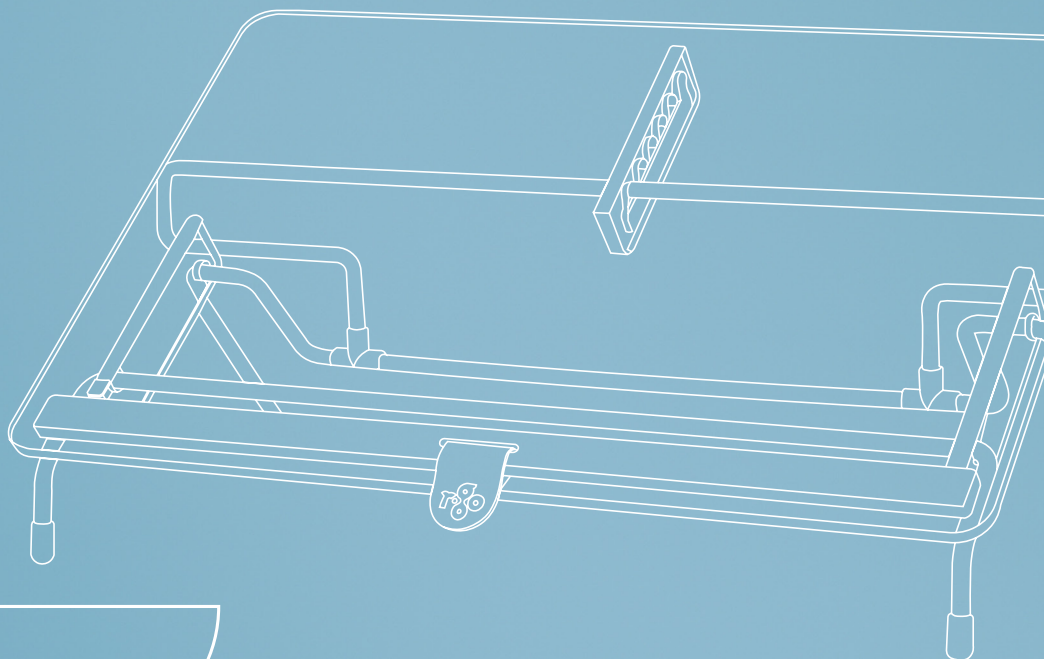

porte- documents ergonomique

R-Go Flex Read

Mise en place

Etape A

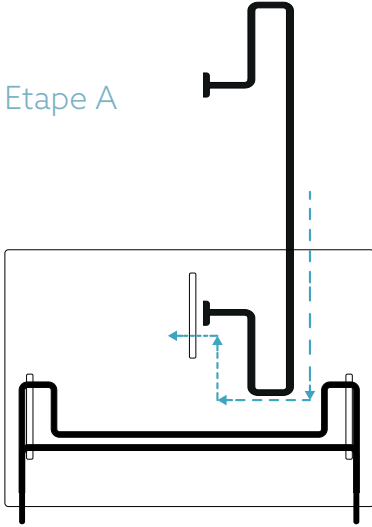

Etape B

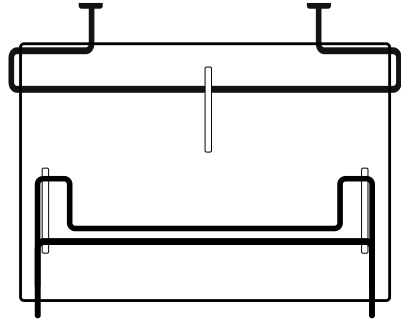

Etape C

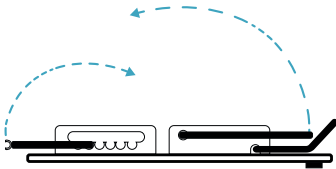

Etape D

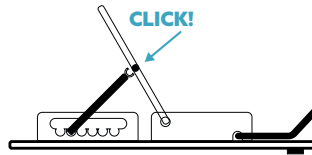

Etape E

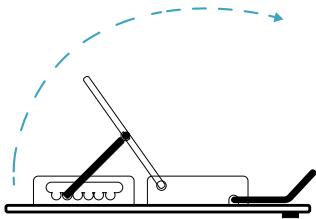

Etape F

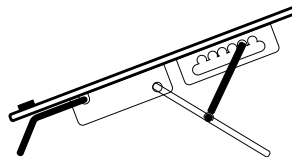

Produit final

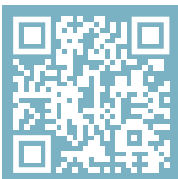
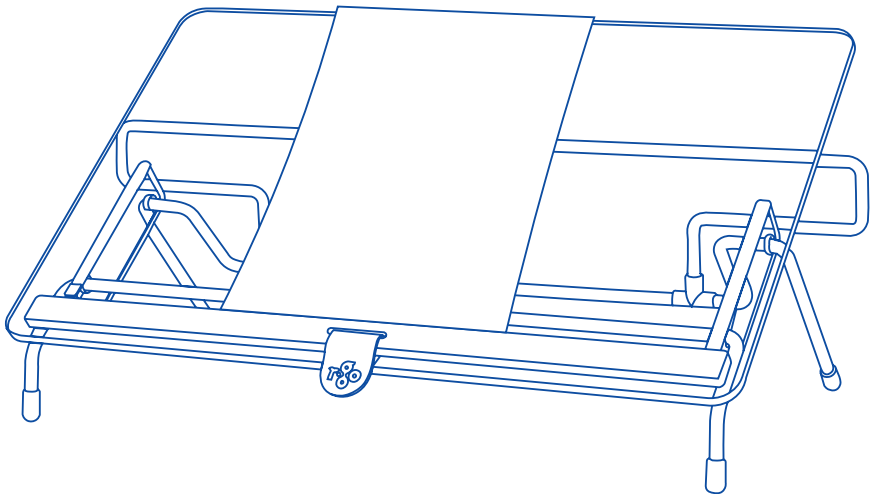

Pour plus d'informations
sur ce produit,
scannez le code QR!
https://r-go.tools/flexread_web_fr



ergonomische document- houder

R-Go Flex Read

Installatie voor gebruik

Stap A

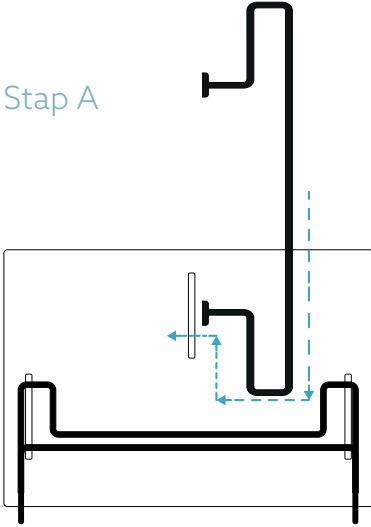

Stap B

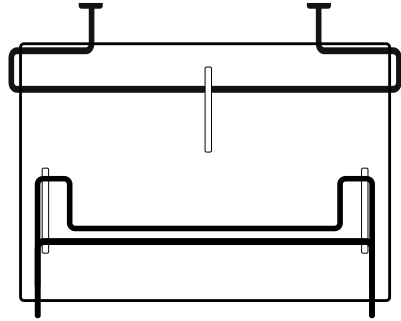

Stap C

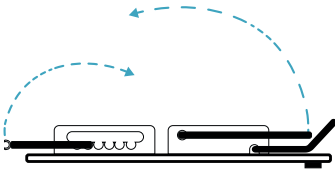

Stap D

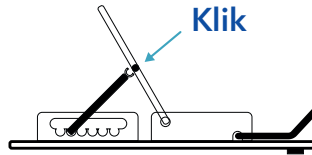

Stap E

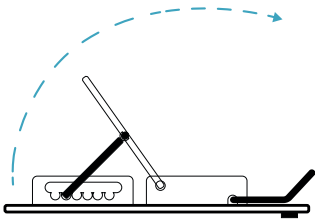

Stap F

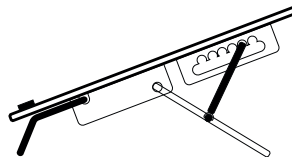

Eindproduct

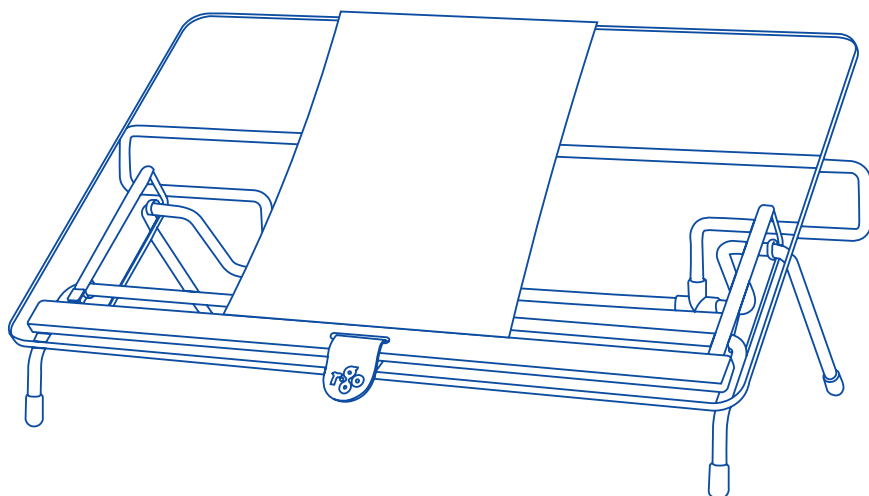

Scan de QR-code voor
meer informatie over
dit product!
https://r-go.tools/flexread_web_nl

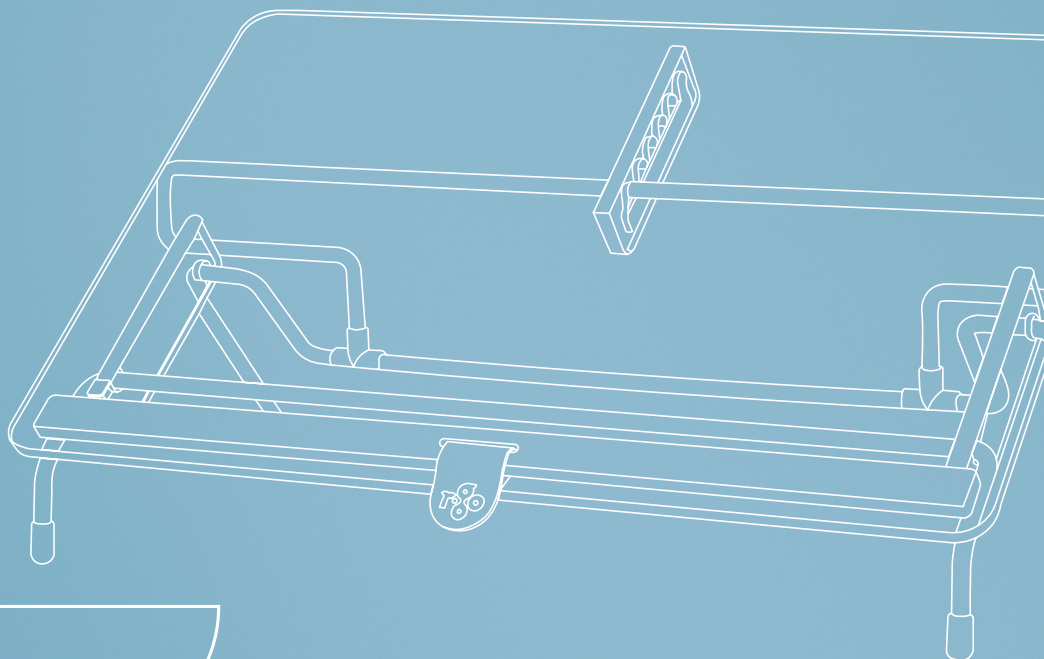

ergonomiczny uchwyt na dokumenty

R-Go Flex Read

Konfiguracja

Krok A

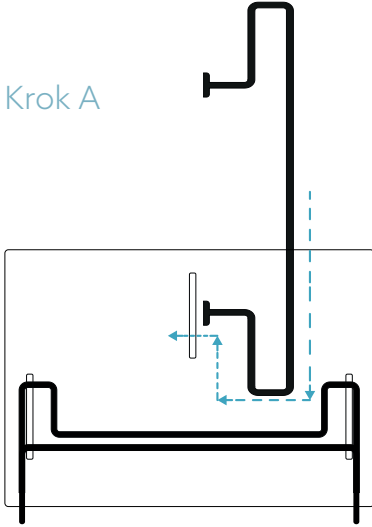

Krok B

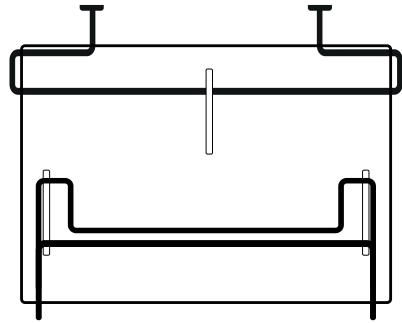

Krok C

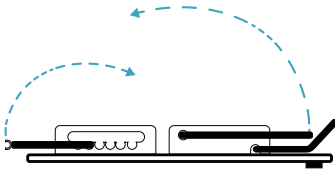

Krok D

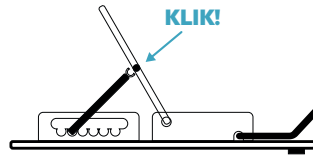

Krok E

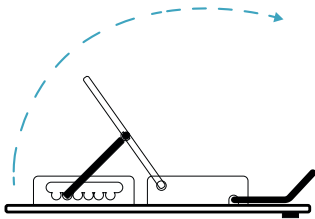

Krok F

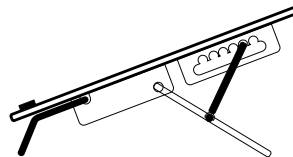

Produkt końcowy

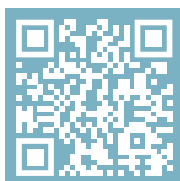
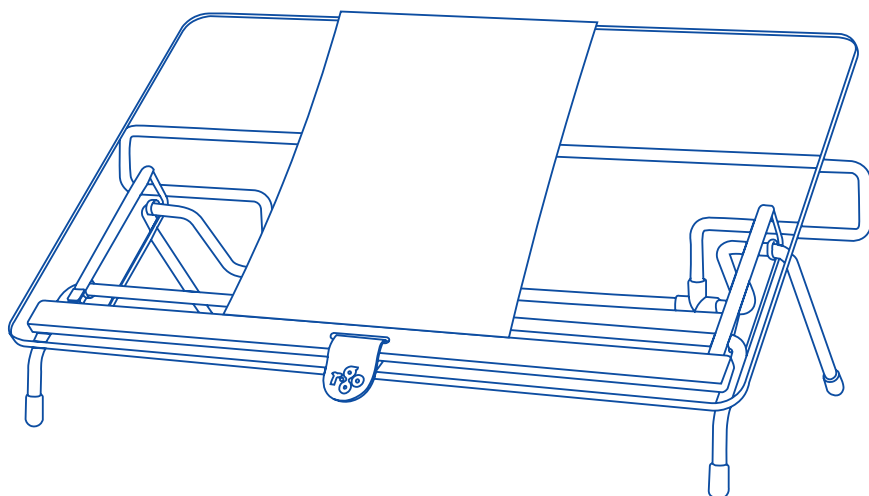

Aby uzyskać więcej informacji
o tym produkcie,
zeskanuj kod QR!
https://r-go.tools/flexread_web_pl

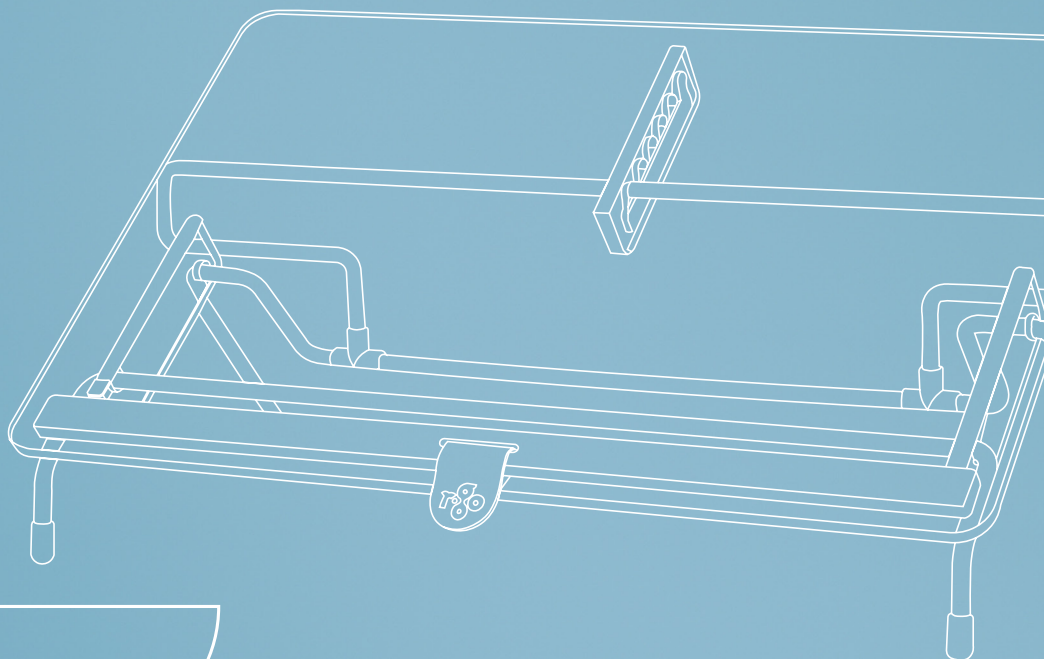

porta- documentos ergonómico

R-Go Flex Read

Configuración

Paso A

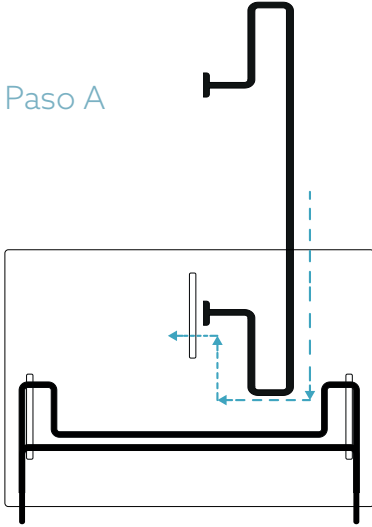

Paso B

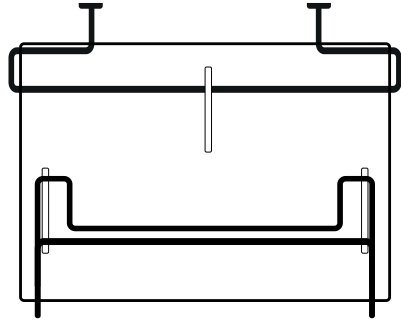

Paso C

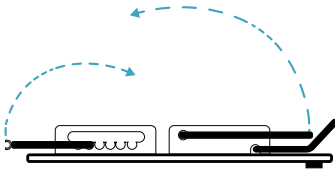

Paso D

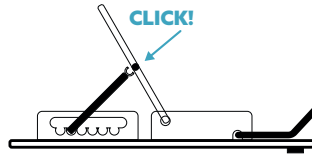

Paso E

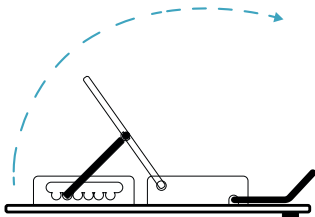

Paso F

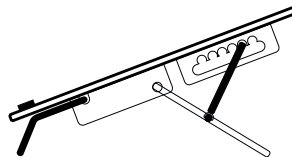

Producto final

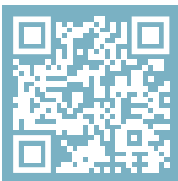
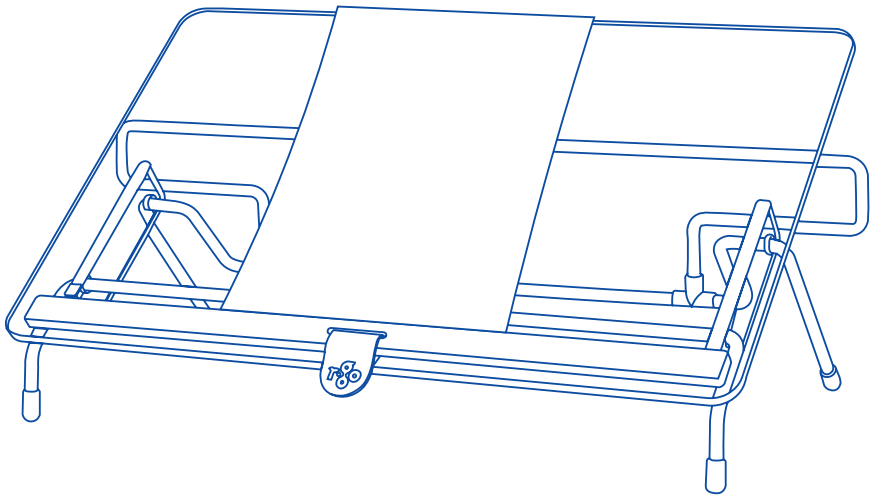

Para más información
sobre este producto
¡escanea el código QR!
https://r-go.tools/flexread_web_es

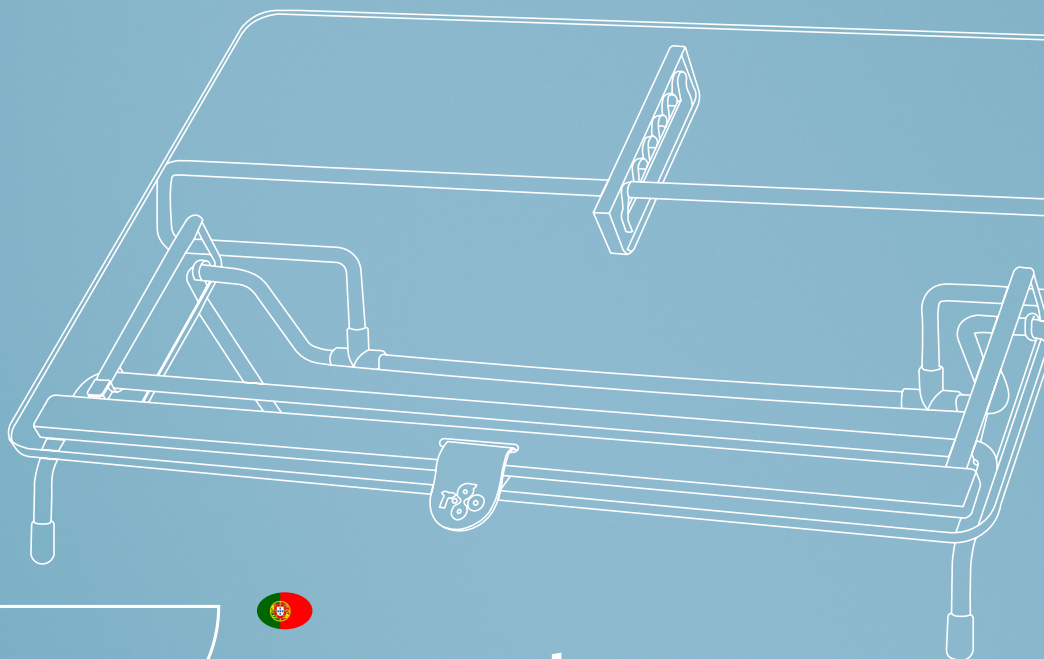

suporte ergonómico para documentos

R-Go Flex Read

Instalação

Passo A

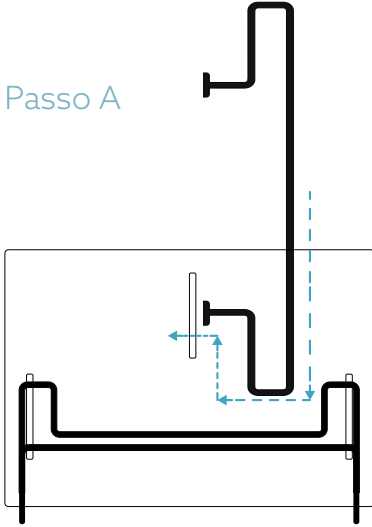

Passo B

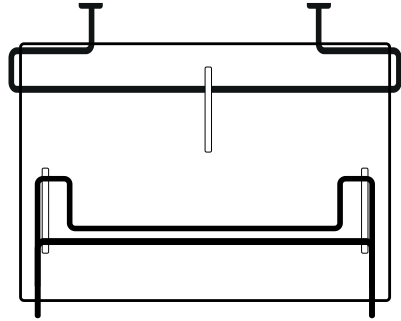

Passo C

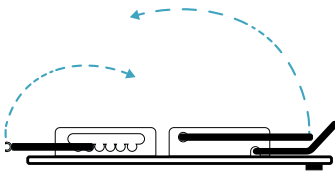

Passo D

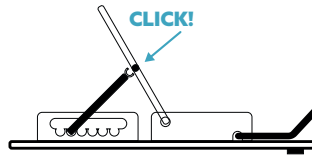

Passo E

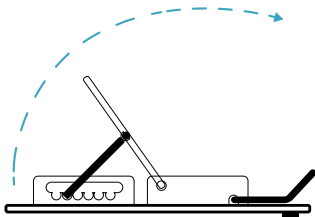

Passo F

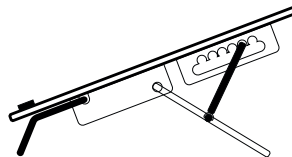

Produto final

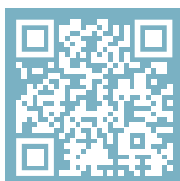
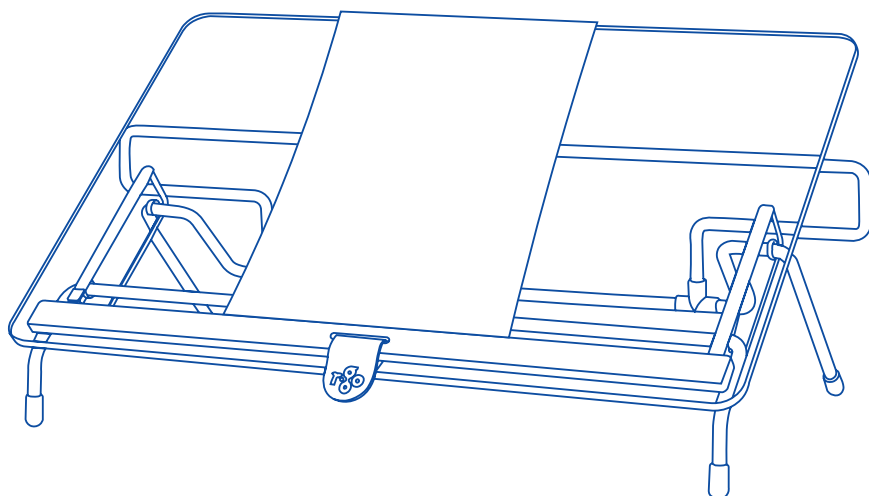

Para obteres mais informações
sobre este produto,
lê o código QR!
https://r-go.tools/flexread_web_pt

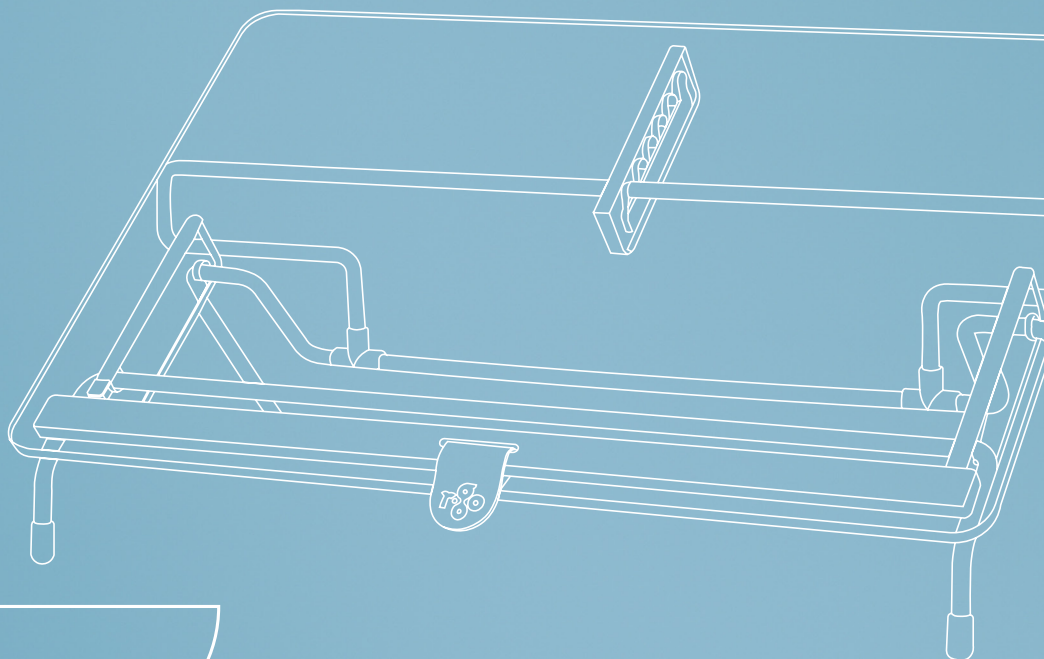

porta- documenti ergonomico

R-Go Flex Read

Installazione

Passo A

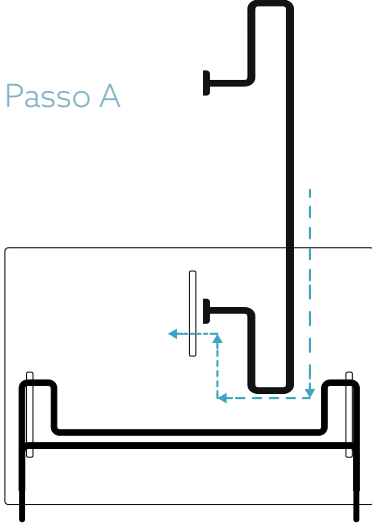

Passo B

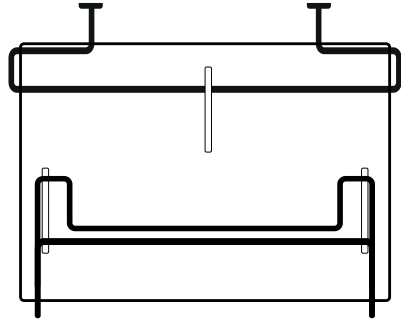

Passo C

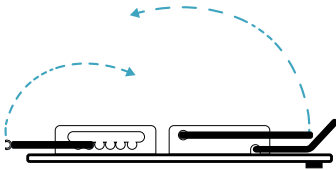

Passo D

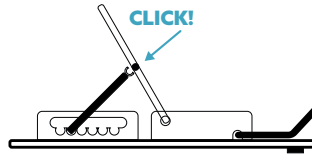

Passo E

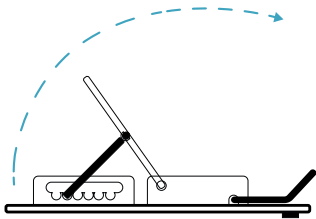

Passo F

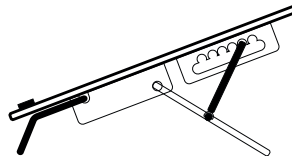

Prodotto finale

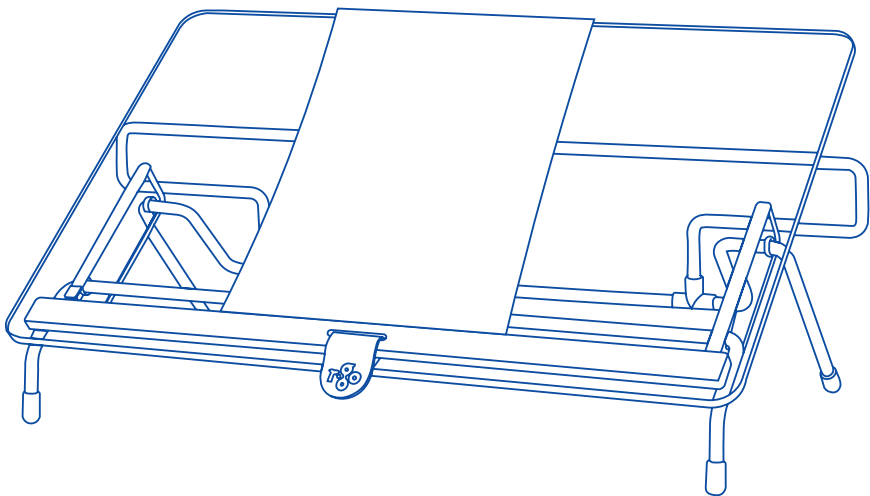

Per ulteriori informazioni
su questo prodotto,
scansiona il codice QR!
https://r-go.tools/flexread_web_it

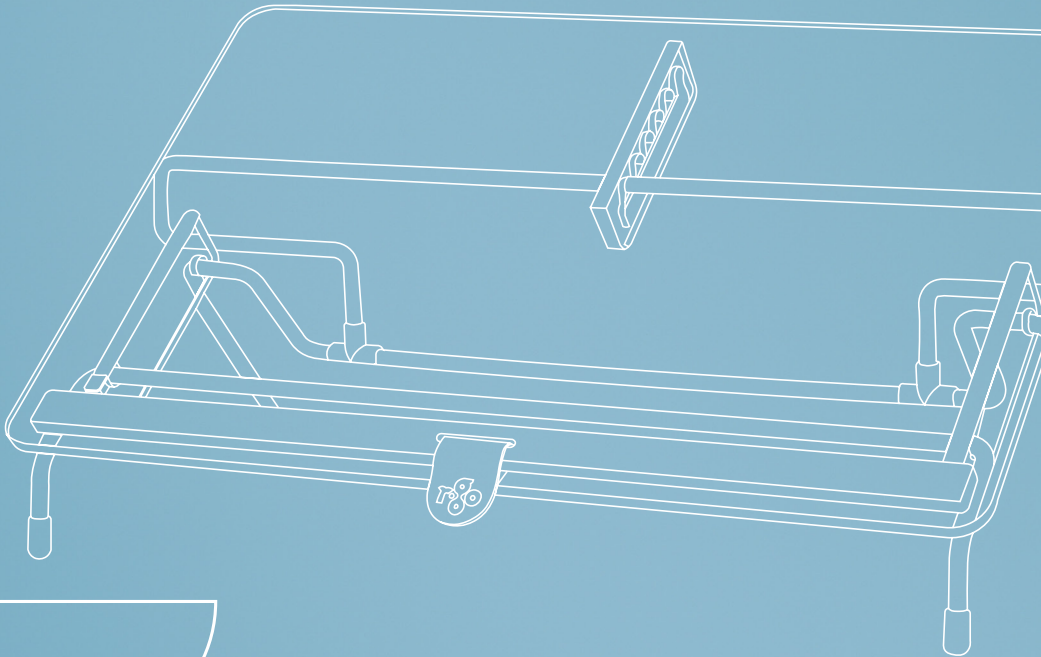

ergonomisk dokument- hållare

R-Go Flex Read

Inställning

Steg A

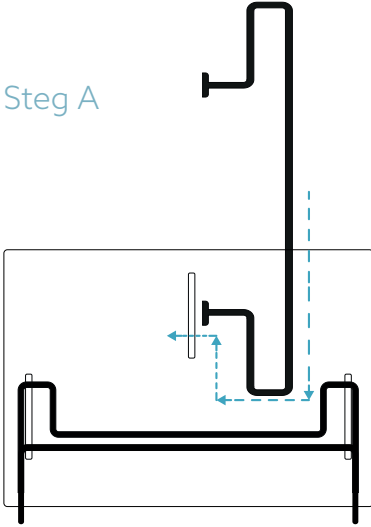

Steg B

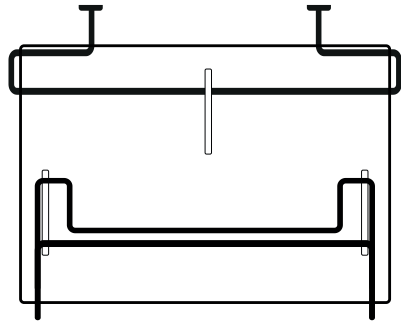

Steg C

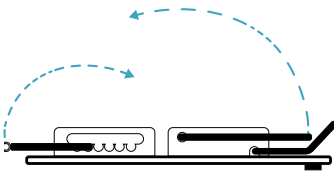

Steg D

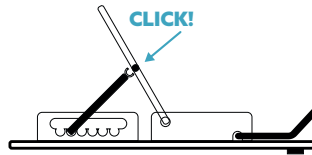

Steg E

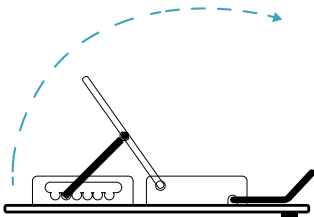

Steg F

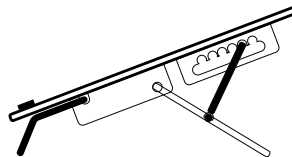

Slutlig produkt

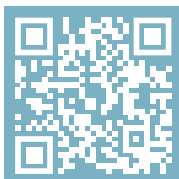
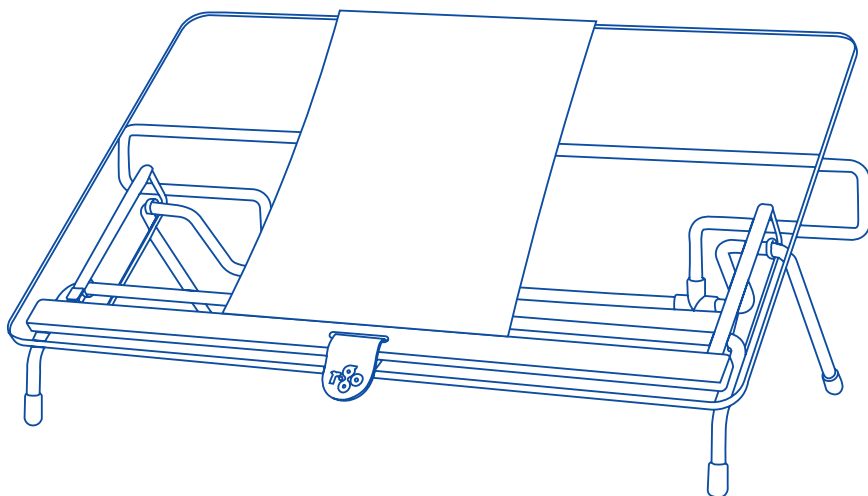

För mer information
om den här produkten,
skanna QR-koden!
https://r-go.tools/flexread_web_se